



Laser Diode Controller

LDC200C Series Operation Manual



2014

Version: 6.2
Date: 31-Jan-2014

Contents

Foreword	3
1 General Information	4
1.1 Laser Diode Protection Features	5
1.2 Safety	5
1.3 Ordering Codes and Accessories	7
2 Getting Started	8
2.1 Parts List	8
2.2 Preparation	8
2.3 Operating elements	9
2.4 First Operation	10
3 Operating Instruction	11
3.1 External Connections	11
3.1.1 Laser Diode Output	11
3.1.2 LD and PD polarities	12
3.1.3 Interlock	13
3.1.4 Analog Out	14
3.2 Setting the Current Limit	14
3.3 Constant Current Mode (CC)	14
3.4 Constant Power Mode (CP)	15
3.5 Calibration of Optical Power Display	16
3.6 External Analog Modulation	17
3.7 Overtemperature Protection	17
3.8 Disabling the Beeper	18
3.9 Remote Operation	18
4 Maintenance and Service	20
4.1 Line Voltage Setting	20
4.2 Replacing Mains Fuses	21
4.3 Troubleshooting	22
5 Appendix	24
5.1 Technical Data	24
5.1.1 LDC200CV	25
5.1.2 LDC201CU	26
5.1.3 LDC202C	27
5.1.4 LDC205C	28
5.1.5 LDC210C	29
5.1.6 LDC220C	30
5.1.7 LDC240C	31

5.2 Certifications and Compliances _____	32
5.3 Warranty _____	33
5.4 Copyright and Exclusion of Reliability _____	34
5.5 Thorlabs 'End of Life' Policy (WEEE) _____	35
5.6 Thorlabs Worldwide Contacts _____	36

We aim to develop and produce the best solution for your application in the field of optical measurement technique. To help us to live up to your expectations and improve our products permanently we need your ideas and suggestions. Therefore, please let us know about possible criticism or ideas. We and our international partners are looking forward to hearing from you.

Thorlabs GmbH

Warning

Sections marked by this symbol explain dangers that might result in personal injury or death. Always read the associated information carefully, before performing the indicated procedure.

Attention

Paragraphs preceded by this symbol explain hazards that could damage the instrument and the connected equipment or may cause loss of data.

Note

This manual also contains "NOTES" and "HINTS" written in this form.

Please read these advices carefully!

1 General Information

The Thorlabs LDC200C Series Laser Diode Controllers are high accuracy precise injection current controllers for laser diodes and LEDs. Together with a Thorlabs Temperature Controller a stable operation of the connected laser diode can be achieved. The LDC200C Series includes the following types:

- LDC200CV - designed for safe operation of VCSEL laser diodes.
- LDC201CU - ultra low noise current ($<0.2\mu\text{A}$ RMS).
- LDC202C, LDC205C and LDC210C - enhanced compliance voltage ($>10\text{V}$) for use with blue laser diodes.
- LDC240C - higher current (4A).

The LDC200C Series controllers are easy to operate via the operating elements on the front panel. Operating parameters are shown on a 5-digit LED display. UP-DOWN keys allow to select the parameter to be displayed.

After switching on a LDC200C Series laser diode controller, it remains in LASER OFF mode. The laser current can be switched on/off using the appropriate key at the front panel.

Additionally the laser current can be switched by applying a TTL signal to the LD remote input at the rear of the unit.

The laser and the photodiode are connected via a 9-pin D-SUB jack at the rear of the unit. The output for the laser diode and the input for the photodiode are bipolar, thus all polarities of commercial available laser diodes can be connected.

The injection current or the optical output power of the laser diode can be modulated applying a modulation signal to the input at the rear of the unit.

A voltage proportional to the laser diode current is provided for monitoring purposes at an analog control output at the rear.

If an error occurs or the limit for the laser current is reached, the corresponding LED lights up and a short beep gives a warning.

For a low ripple and noise of the output current a mains filter is installed and the transformer is shielded carefully.

The LDC200C Series controller are cooled by an internal fan, which protects the unit against overheating in case of high environmental temperatures. With free air circulation a safe operation of the unit is guaranteed up to $40\text{ }^{\circ}\text{C}$ ambient temperature.

Warning

Do not obstruct the air ventilation slots in the housing!

Note

In order to prevent damages to the laser diode, it is recommended to mount the laser into a suitable Thorlabs laser diode mount and connect it to the LDC200C Series using the supplied Thorlabs CAB400 cable. This ensures the utmost protection of the laser diode from damage by wrong connection.

1.1 Laser Diode Protection Features

- **Soft start function**
The soft start function protects the laser diode against undesired transients by smoothly increasing the injection current after switching the laser on. This current ramp last for abt. 200 msec.
- **Adjustable limitation of laser current**
An adjustable hardware limit for the laser current can be set using the 12 turn potentiometer at the front panel. This protects the laser diode from unintentional laser current values.
- **Contact protection of the laser diode (open circuit)**
If the connection to the laser is interrupted during operation even for a very short time, the output is switched off immediately and can be switched on manually only.
- **Electronic short-circuit for the laser diode in LASER OFF mode**
With the output switched off the laser diode is short-circuited electronically, thus the laser diode is protected against accidental ESD and induced current transients.
- **Line failure protection**
The laser current is switched off immediately if a power failure or line interruption occurs. In this case, same as after turning on the controller, the laser current remains switched off and can be switched on manually only.
- **Interlock**
The interlock interface provides a number of several protection functions simultaneously.
 - Safety lock to prevent unintentional use
 - Cable disconnect or damage monitoring
 - An external emergency switch can be connected
 - Application of external automatic protection and alerting equipment
 - External LED to indicate "Laser ON"

The laser can only be switched on with the interlock input closed. If the interlock contact is opened during operation (even for a very short time) the output is switched off immediately and can be switched on manually only.

1.2 Safety

Attention

All statements regarding safety of operation and technical data in this instruction manual will only apply when the unit is operated correctly as it was designed for.

All modules must only be operated with proper shielded connection cables.

Only with written consent from Thorlabs may changes to single components be carried out or components not supplied by Thorlabs be used.

This precision device is only serviceable if properly packed into the complete original packaging including the plastic foam sleeves. If necessary, ask for a replacement package.

Before applying power to your LDC200C Series controller, make sure that the protective conductor of the 3 conductor mains power cord is correctly connected to the protective earth contact of the socket outlet!

Improper grounding can cause electric shock with damages to your health or even death!

Also make sure that the line voltage setting of the fuse holder at the rear panel agrees with your local supply and that the corresponding fuses are inserted. If not, please change the line voltage setting (see section [Line voltage setting](#)^[20]) and the mains fuses (see section [Replacing the mains fuses](#)^[21]).

The LDC200C Series controller must not be operated in explosion endangered environments!

Do not obstruct the air ventilation slots in housing!

Do not remove covers!

Refer servicing to qualified personnel!

Warning

Laser modules can deliver up to several 100mW of maybe even invisible laser radiation! When operated incorrectly, this can cause severe damage to your eyes and health! Be sure to pay strict attention to the safety recommendations of the appropriate laser safety class, as stated for the used laser diode.

Attention

Use only duly shielded connection cables for laser, photodiode and control input/output connections.

Mobile telephones, cellular phones or other radio transmitters must not be used within the range of three meters of this unit since the electromagnetic field intensity may then exceed the maximum allowed disturbance values according to IEC61326-1.

This product has been tested and found complying with the limits according to IEC 61326-1 for using connection cables shorter than or equal to 3 meters (9.8 feet).

Attention

The following statement applies to the products covered in this manual, unless otherwise specified herein. The statement for other products will appear in the accompanying documentation.

Note: This equipment has been tested and found to comply with the limits for a Class B digital device, pursuant to Part 15 of the FCC Rules and meets all requirements of the Canadian Interference-Causing Equipment Standard ICES-003 for digital apparatus. These limits are designed to provide reasonable protection against harmful interference in a residential installation. This equipment generates, uses, and can radiate radio frequency energy and, if not installed and used in accordance with the instructions, may cause harmful interference to radio communications. However, there is no guarantee that interference will not occur in a particular installation. If this equipment does cause harmful interference to radio or television reception, which can be determined by turning the equipment off and on, the user is encouraged to try to correct the interference by one or more of the following measures:

- Reorient or relocate the receiving antenna.
- Increase the separation between the equipment and receiver.
- Connect the equipment into an outlet on a circuit different from that to which the receiver is connected.
- Consult the dealer or an experienced radio/T.V. technician for help.

Thorlabs GmbH is not responsible for any radio television interference caused by modifications of this equipment or the substitution or attachment of connecting cables and equipment other than those specified by Thorlabs GmbH. The correction of interference caused by such unauthorized modification, substitution or attachment will be the responsibility of the user.

The use of shielded I/O cables is required when connecting this equipment to any and all optional peripheral or host devices. Failure to do so may violate FCC and ICES rules.

1.3 Ordering Codes and Accessories

Ordering code Short description

LDC200CV	Laser diode controller, current range 0 ... 20 mA / 6 V
LDC201CU	Laser diode controller, current range 0 ... 100 mA / 5 V, Ultra Low Noise
LDC202C	Laser diode controller, current range 0 ... 200 mA / 10 V
LDC205C	Laser diode controller, current range 0 ... 500 mA / 10 V
LDC210C	Laser diode controller, current range 0 ... 1 A / 10 V
LDC220C	Laser diode controller, current range 0 ... 2 A / 4 V
LDC240C	Laser diode controller, current range 0 ... 4 A / 5 V

Shielded cable:

CAB400	Cable to connect the LDC200C Series controller to a Thorlabs Laser Diode Mount (included)
---------------	---

Laser diode mounts for different laser diode packages:

TCLDM9	Temperature controlled laser diode mount for 3- and 4-pin TO18-packages (9 mm CD, 5.6 mm CD)
LDM21	Miniature sized temperature controlled laser diode mount for 3- and 4-pin TO18-packages (9 mm CD, 5.6 mm CD)
LM14S2	laser diode mount for laser modules in a 14-pin butterfly-package (programmable pinning)

Please visit our homepage <http://www.thorlabs.com> for further information.

2 Getting Started

2.1 Parts List

Inspect the shipping container for damage.

If the shipping container seems to be damaged, keep it until you have inspected the contents and you have inspected the LDC200C Series controller mechanically and electrically.

Verify that you have received the following items within the package:

1. 1 LDC200C Series controller
2. 1 power cord, connector according to ordering country
3. 1 operation manual
4. 1 connection cable CAB400

2.2 Preparation

Prior to operate a LDC200C Series controller, check if the set line voltage matches with your local power supply and if the appropriate fuses are inserted. (See sections [Line Voltage Setting](#) ²⁰ and [Replacing the Mains Fuses](#) ²¹)

Connect the unit to the power line using the supplied cable. Turn the unit on by pressing the [line switch \(F10\)](#) ⁹.

If required, the chassis ground can be connected to ground potential via the connector jack (R5). The ground pin of the laser diode is internally connected to chassis ground.

2.3 Operating elements

Front Panel

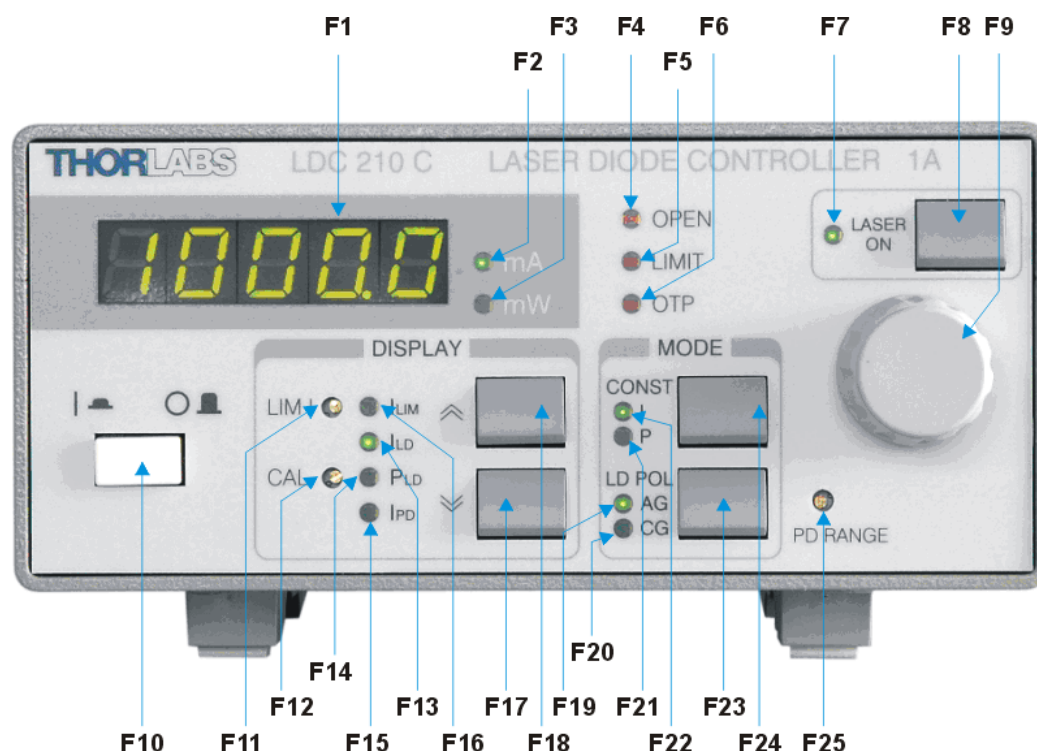

F1	-	5-digit LED display
F2	LED "mA"	Current display in mA
F3	LED "mW"	Power display in mW
F4	LED "OPEN"	No laser diode connected, or Interlock open
F5	LED "LIMIT"	Adjusted current limit reached
F6	LED "OTP"	Overtemperature protection is active
F7	LED "LASER ON"	Laser current is switched on
F8	Key "LASER ON"	On / Off switch for the laser current
F9	-	Knob for adjusting the current or power set value
F10	-	Line switch (ON / OFF)
F11	LIM I	Potentiometer for setting the current limit
F12	CAL	Potentiometer for calibrating the power display
F13	LED "I _{LD} "	Display shows the laser current
F14	LED "P _{LD} "	Display shows the optical power
F15	LED "I _{PD} "	Display shows the photodiode current
F16	LED "I _{LIM} "	Display shows the current limit
F17	Key "DOWN"	Select the parameter to be displayed
F18	Key "UP"	Select the parameter to be displayed
F19	LED "AG"	Selected laser polarity: anode grounded
F20	LED "CG"	Selected laser polarity: cathode grounded
F21	LED "P"	Constant power mode
F22	LED "I"	Constant current mode
F23	Key "LD POL"	Select laser polarity: anode grounded or cathode grounded
F24	Key "CONST"	Select constant current mode or constant power mode
F25	PD RANGE	Potentiometer for setting the photodiode current range

Rear Panel

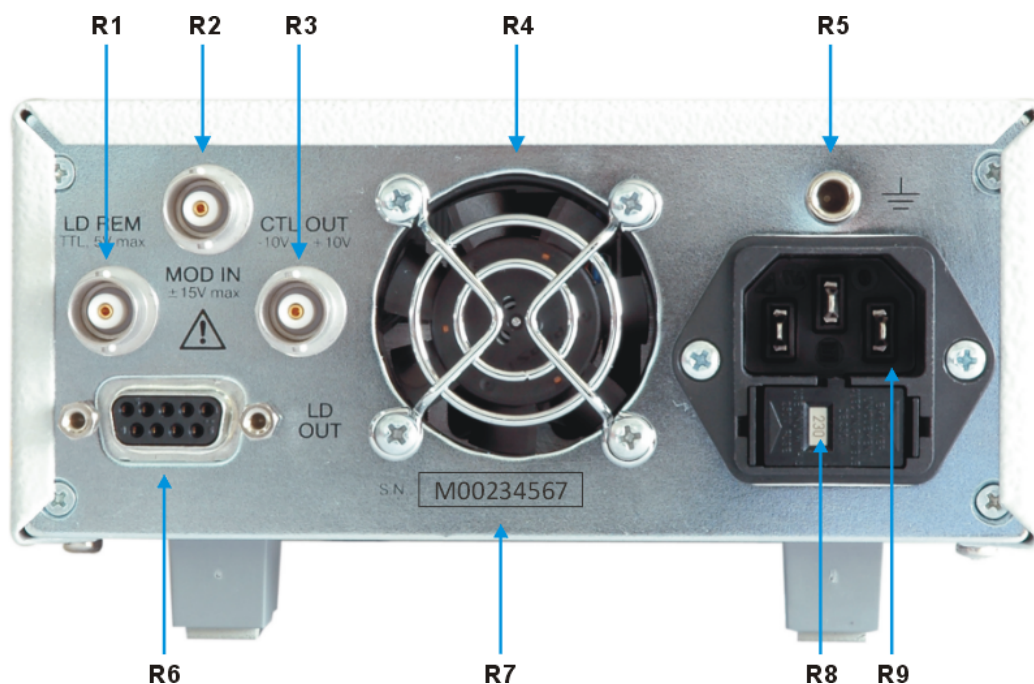

- R1** TTL input "LD REM", 0 ... +5 V
- R2** Modulation input / analog control input "MOD IN", -10V ... +10 V
- R3** Analog monitoring output "CTL OUT", 0 ... ±10V
- R4** Fan
- R5** 4 mm banana jack for chassis ground
- R6** Connector "LD OUT" for laser diode, photodiode, interlock, status LED
- R7** Serial number of the unit
- R8** Indicator / switch for line voltage (included in fuse holder)
- R9** Mains connector and fuse holder

2.4 First Operation

Attention

Prior to switching on your LDC200C Series controller, please make sure that the [line voltage setting](#)^[20] corresponds to your mains voltage! Mismatching may lead to damage of the controller!

Turn the unit on by pressing the line switch (F10).

After switching on the unit, the LED display (F1) and a LED, indicating the selected measurement value (F13 ... F16), light up, otherwise please check the [line voltage](#)^[20] and the [mains fuses](#)^[21].

By using the keys (F17) and (F18) the displayed measurement value can be selected.

A LDC200C Series controller is immediately ready to use after turning on. The rated accuracy is reached, however, after a warming-up time of approx. 10 minutes.

3 Operating Instruction

3.1 External Connections

Prior to switch on the LDC200C Series controller, all required external connections must be made properly. Please read the following sections carefully.

3.1.1 Laser Diode Output

The Thorlabs LDC200C Series controller can drive all laser diodes depending on the model up to a maximum current of 4 A.

If a Thorlabs laser mount is used, just connect the 9-pin D-Sub jack "LD OUT" (R6) ^[10] of LDC200C Series controller to the 9-pin plug "LD DRIVER" of the Laser Diode Mount using the supplied shielded cable CAB400.

If a Thorlabs laser mount TCLDM9 or LDM21 is used, in addition the polarity of laser diode and photodiode must be set using the two slide switches at the laser mount. Please refer to the individual operation manual of the laser diode mount.

If other laser diode fixtures are used, connect the laser diode and - if provided - the photodiode using shielded cables to "LD OUT" (R6) according to the pin assignment as shown below:

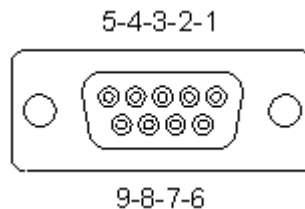

Pin assignment of the "LD OUT" jack (female, rear panel view)

Pin # Connection

Interlock (open circuit monitoring, status display)

- | | |
|---|-------------------------------------|
| 1 | interlock and status LASER ON / OFF |
| 5 | ground for pin 1 |

Laser Diode

- | | |
|---|---|
| 7 | laser diode cathode (in case of polarity "anode grounded" - AG) |
| 8 | laser diode anode (in case of polarity "cathode grounded" - CG) |
| 3 | laser diode ground |

Photodiode

- | | |
|---|--------------------|
| 2 | photodiode cathode |
| 4 | photodiode anode |

Note

Do not connect the laser diode between pin 7 and 8! The correct connection must be:

- for laser diode "AG": cathode to pin 7, anode to pin 3, pin 8 - open
- for laser diode "CG": anode to pin 8, cathode to pin 3, pin 7 - open.

3.1.2 LD and PD polarities

Connect laser and photodiode to the LDC200C Series controller as shown below.

The ground connection of the laser diode (pin 3) can be connected to the anode of the photodiode (pin 4), or to the cathode of the photodiode (pin 2). This connection should be as close as possible to the laser diode to avoid measurement errors.

If the selected polarity (key "LD POL" [F23](#)) and the pin connection of the laser diode do not match, no current is flowing through the laser diode.

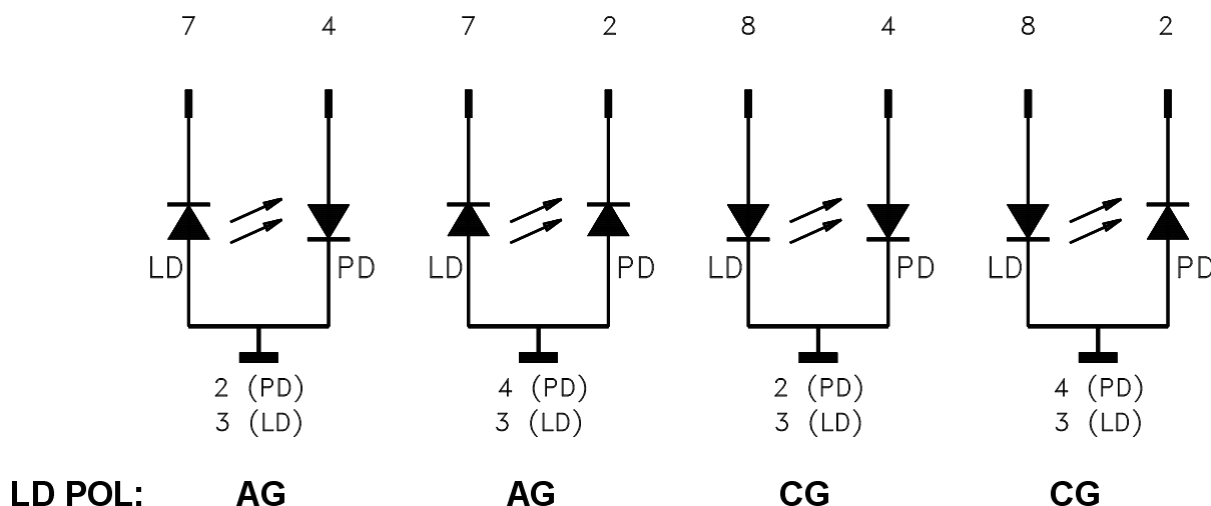

The laser diode is always sourced with respect to ground. Compared to a floating ground scheme, the advantages of this operation mode are higher safety for the laser diode, better stability of the laser current and less introduced interferences.

Prior to turning on the laser current, the correct polarity of the laser diode must be selected:

- Make sure the laser is switched off (key "LASER ON" F8).
- Select the required polarity by pressing the key "LD POL" (F23).
- For laser diodes with a built-in monitor diode the common pin of laser diode and photodiode is the ground pin.
- The selected polarity of the output is indicated by the LED "AG" (F19) or "CG" (F20).

If the laser diode was connected correctly (see above) but the polarity of the laser diode was selected wrong with the key "LD POL" (F23), an "OPEN" error will be indicated (LED "OPEN" F4).

After pressing "LASER ON" (F8) the LED "OPEN" (F4) extinguishes and the output can be switched on by pressing "LASER ON" (F8) again.

Biasing the photodiode

If the photodiode shall be operated with bias voltage, a battery can be connected in series to the photodiode.

If the photodiode is of AG polarity, connect the positive terminal of the battery to the cathode of the photodiode, and the negative terminal of the battery to pin 2.

If the photodiode is of CG polarity, connect the negative terminal of the battery to the anode of the photodiode, and the positive terminal of the battery to pin 4.

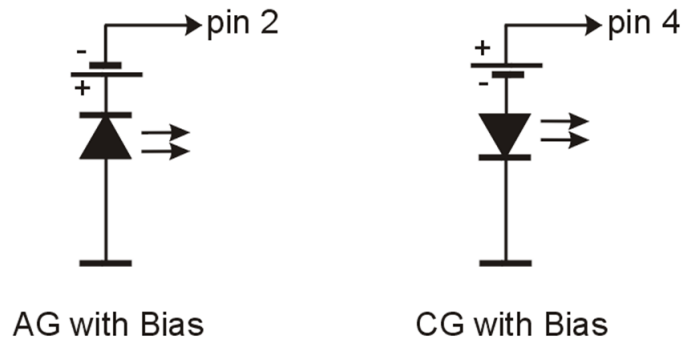

Attention

A wrong polarity of the battery may destroy the photodiode due to a forward current flowing through it!

3.1.3 Interlock

Pin 1 and pin 5 of the ["LD OUT" jack \(R6\)](#)^[11] are the interface of the interlock circuit.



The interlock output represents a current source, while the voltage across the external circuit, connected to pin 1 and 5, is being observed. As soon as this voltage rises above a certain threshold ($\sim 2.5\text{V}$), the external circuit is considered as "open", the laser current output is disabled and the [LED "OPEN" \(F4\)](#)^[9] lights up .

Pin 1 and pin 5 must be connected externally by a short cut wire, by a circuit (total resistance $< 430\ \Omega$) or by a LED (anode to pin 1, cathode to pin 5, connect in parallel resistor $R=1\ \text{k}\Omega$). A connected LED lights up when the laser current is switched on (LASER ON).

Note

Do not use blue LED due to their high forward voltage

Thorlabs Laser Diode Mounts use the interlock current for indication "LD ON". When using a Thorlabs TCLDM9 or LM14S2 laser diode mount, interlock functionality can be easily used for emergency switch-off of the laser by connecting an opening contact to the jack located on the laser mount. For details, please refer to the appropriate laser diode mount manual.

3.1.4 Analog Out

The output "CTL OUT" (R3)^[10] delivers a DC voltage, proportional to the actual laser current. The output voltage ranges from:

- 0 ... +10 V with cathode grounded
- 0 ... -10 V with anode grounded.

When connecting a load avoid ground loops. The load resistance should be >10 kΩ. The conversion coefficient for this output can be calculated to:

$$k_{CTL\ OUT} = 10V/I_{max} \text{ [V/mA]}$$

where I_{max} is the max. output current for the given controller.

Example:

For an LDC202C with a max. output current of 200mA the conversion coefficient $k_{CTL\ OUT}$ is equal to 0.05 V/mA.

3.2 Setting the Current Limit

Prior to switch on the laser diode, always set an appropriate injection current limit to protect the laser diode from destruction:

- Switch on the unit - button "LINE" (F10).
- Make sure the laser current is switched off
- Select parameter "I_{LIM}" (key F17 or F18).
- Use a screwdriver to set the desired current with the potentiometer "LIM I" (F11).

Note

The current limit can be displayed at any time by selecting the parameter "I_{LIM}"

If the laser current reaches it's limit during operation, the LED "LIMIT" (F5) lights up and a short beep alerts about that. The current limit can also be adjusted when the output is switched on. Avoid any adjustments when the LED "LIMIT" (F5) lights up.

3.3 Constant Current Mode (CC)

- Switch on the LDC2xxC.
- Make sure, that the current limit "I_{LIM}" is [adjusted properly](#)^[14].
- Make sure that the correct [laser diode polarity](#)^[12] is set.
- [Connect the laser diode](#)^[12].
- Select the display "I_{LD}" using the keys (F17) or (F18).
- Turn the adjust knob (F9) completely counter clockwise.
- Select constant current mode ("I") by pressing the key "CONST" (F24) until LED "I" (F22) lights up.
- Switch on the output by pressing the key "LASER ON" (F8). The LED "LASER ON" (F7) lights up, the output is activated and the current slowly rises (about 1 s) to the value set with knob (F9).

Note

The current output can be switched on only if the jack "LD OUT" (R6) is connected correctly

The display shows the injection current "ILD".

With the adjust knob (F8) the laser current can be set continuously between 0 mA and the selected current limit "ILIM".

- ⇒ If the injection current "ILD" reaches the set current limit "ILIM" during operation, the LED "LIMIT" (F5) lights up, a short alert beep is heard, and the laser current is limited to the value of the current limit "ILIM". In this case, noise and ripple do not longer correspond to the specifications for normal operation. However exceeding the set current limit "ILIM" is impossible.
- ⇒ If the connection to the laser diode is interrupted during operation, the laser diode current is switched off automatically. LED "LASER ON" (F7) extinguishes, LED "OPEN" (F4) lights up and a short beep is heard.
- ⇒ If the output is switched on while the interlock is closed and there is no laser diode connected, at first the LED "LASER ON" (F7) lights up and the output is switched on. Then the LDC2xxC recognizes the missing laser diode and switches the output off. The LED "LASER ON" (F7) extinguishes and the LED "OPEN" (F4) lights up. Connect the laser and press "LASER ON" (F8) - the LED "OPEN" (F4) extinguishes and the output switches on.
- ⇒ If a photodiode is connected, the display can be set to show the photodiode current "IPD" or the optical power "PLD" by pressing the key (F17) or (F18).

The laser current can be [modulated](#)¹⁷⁾ via the connector "MOD IN" (R2).

3.4 Constant Power Mode (CP)

If the laser includes a photodiode (also known as monitor diode), the laser can be operated also in constant power mode. In contrast to the constant current mode, here the photodiode current is kept constant by controlling the laser injection current.

- Start operating the LDC2xxC in constant current mode (refer to chapter 3.4)
- Select the display "IPD" with the key (F17) or (F18).
- Check whether an appropriate photodiode current "IPD" is available. A photodiode current of at least the minimum control current must be available for a stable operation of the power control:
 - 5 μ A for LDC200CV,
 - 25 μ A for LDC201CU, LDC202C, LDC205C,
 - 50 μ A for LDC210C, LDC220C, LDC240C.

Note

If the sign of the photodiode current "IPD" is negative, the photodiode must be reversed.

- Switch off the laser current by pressing the key "LASER ON" (F8) .
 - Select constant power mode ("P") by pressing the key "CONST" (F24) until LED "P" (F21) lights up.
 - Set the adjust knob (F9) completely counter clockwise.
 - Switch on the output by pressing "LASER ON" (F8). The LED "LASER ON" (F7) lights up, the output is activated and the current slowly increases (about 1 s) to the set value.
 - The photodiode current "IPD" can be set using (F9) and with that the optical power of the laser diode increases until the laser current "ILD" reaches the selected current limit "ILIM".
- ⇒ If the desired photodiode current "IPD" cannot be set with a sufficient accuracy (F9), the range of the knob (F9) can be fitted to the current range of the connected photodiode using the potentiometer "PD RANGE" (F25) - see below.

- ⇒ If no photodiode is connected or the polarity of the photodiode is set wrong, the laser current "I_{LD}" increases to the limit "I_{LIM}" after the output is switched on.
- ⇒ If the connection to the photodiode is interrupted in constant power mode, the laser current "I_{LD}" increases to the set current limit "I_{LIM}".
- ⇒ If the injection current "I_{LD}" is limited by the selected current limit "I_{LIM}", ripple and noise do not longer correspond to the specifications for normal operation. However, the set maximum current "I_{LIM}" cannot be exceeded.
- ⇒ If the connection to the laser diode is interrupted during operation, the output is switched off automatically. LED "LASER ON" (F7) extinguishes, LED "OPEN" (F4) lights up and a short beep is heard.
- ⇒ If the output is switched on while the interlock is closed and there is no laser diode connected, at first the LED "LASER ON" (F7) lights up and the output switches on. Then the LDC2xxC recognizes the missing laser diode, switches the output off, the LED "LASER ON" (F7) extinguishes and the LED "OPEN" (F4) lights up. Connect the laser, then press "LASER ON" (F8) - the LED "OPEN" (F4) extinguishes and the laser diode current output switches.
- ⇒ The laser current can be modulated via the connector "MOD IN" (R3) - see section [External Analog Modulation](#) ¹⁷.

Changing the "I_{PD}" setting range

With potentiometer "PD RANGE" (F25) the full scale of the adjustment knob (F9) can be set in order to ease the setting of the operating point in constant power mode even with low photodiode current. The photodiode current range depends on the type of the LDC2xxC controller:

- LDC200CV: 0.6 mA to 2 mA
 - LDC201CU, LDC202C, LDC205C: 3 mA to 10 mA
 - LDC210C, LDC220C, LDC240C: 6 mA to 20 mA
-
- Turn the potentiometer "PD RANGE" (F25) completely counter clockwise.
 - Turn the adjust knob (F9) completely counter clockwise.
 - Select constant power mode "P" (key "CONST" F24), connect the laser diode and the photodiode and switch on the laser current by pressing the key "LASER ON" (F8).
 - Set the desired photodiode current with the knob (F9).

If the desired operating point cannot be reached even if the knob (F9) is turned completely clockwise (i.e. I_{PD} > 0.6 mA), turn the potentiometer "PD RANGE" (F25) clockwise until the desired setting range has been reached.

Note

A change of the "PD RANGE" (F25) leads to a change of the power set value in CP mode. In constant current mode the potentiometer "PD RANGE" is without function.

3.5 Calibration of Optical Power Display

Additionally to the photodiode current "I_{PD}", the optical power of the laser diode can be displayed. To achieve a correct optical power display, a calibration (potentiometer "CAL" - F12) must be carried out:

- ⇒ Select constant current mode "I" - key "CONST" (F24).

- ⇒ With the knob (F8), set the laser current "ILD" to an operating point for which the optical output power of the laser diode is known, e.g. from the data sheet of the laser diode. You may also find this operating point by displaying the monitor current "IPD" (F15). A more accurate way is to measure the laser power using an optical power meter.
- ⇒ Select the display "PLD" (F14) - keys (F17) or (F18).
- ⇒ Turn the potentiometer "CAL" (F12) completely counter clockwise.
- ⇒ Select the range at which the displayed power is least higher than the actual optical power:
- ⇒ Press the key "CONST" (F24). While holding it, press the key "Down" (F17). With every keystroke, the decimal point of the display moves to the left. Pressing the key "Up" (F18), the decimal point moves to the right. After reaching the highest range, the decimal point jumps back to the left-most position.
- ⇒ Calibrate the display "PLD" to the value of the actual optical power by adjusting the potentiometer "CAL" (F12) clockwise.

3.6 External Analog Modulation

To generate a time dependent injection current "ILD" or photodiode current "IPD", these settings can be modulated via an independent ground-symmetric modulation input "MOD IN" (R2). Maximum allowed input voltage is $-10\text{ V} \dots +10\text{ V}$, input resistance is $>10\text{ k}\Omega$.

"ILD" and "IPD" are calculated as:

$$ILD = ILD\ SET + ILD\ MAX * U_{MOD} / 10\ V \quad (\text{in constant current mode})$$

or $IPD = IPD\ SET + IPD\ MAX * U_{MOD} / 10\ V \quad (\text{in constant power mode})$

with:

ILD MAX:	Maximum laser current (e.g. 500 mA for LDC205C)
IPD MAX:	Max. photodiode current (e.g. 10 mA for LDC205C; see Control Ranges in "Technical Data" [24])
ILD SET or IPD SET:	value set with knob (F9)
U _{MOD} :	voltage at input "MOD IN" (R2)

Start operation in constant current or constant power mode (refer to chapter 3.4 or 3.5) and adjust the desired set value with the knob (F9).

Connect the modulation source to the jack "MOD IN" (R2). Avoid ground loops when connecting the function generator.

The laser diode current "ILD" can be monitored at the analog output ["CTL OUT" \(R3\)](#) [14].

If the injection current "ILD" reaches the current limit "ILIM" in operation, the LED "LIMIT" (F5) lights up, a short beep is heard, and the laser current is limited to the value of the current limit "ILIM". In this case, ripple and noise do no longer correspond to the specifications for normal operation. However the set maximum current "ILIM" cannot be exceeded.

3.7 Overtemperature Protection

The LDC200C Series controllers come with an internal over-temperature protection. If the internal heat sink is overheated, the output of the controller is disabled automatically. The LED "OTP" (F6) lights up and a short beep is heard. The laser diode current is switched off immediately. Pressing the key "LASER ON" (F8) has no effect in this case.

After the internal heat sink's temperature decreased for about 10°C, the LED "OTP" (F6) extinguishes and the laser current output can be switched on again.

3.8 Disabling the Beeper

If audible signals are unwanted, the beeper can be disabled in this way:

- Press and hold the key “UP” (F18).
- Press the key “Down” (F17). Now the beeper state is displayed:
 - “Sd.On” - Sound ON
 - “Sd.OFF” - Sound OFF

To change the beeper state, hold the key “UP” pressed and toggle the beeper state by pressing “DOWN” key.

3.9 Remote Operation

Although the LDC200C Series Controllers do not provide a standard computer interface, a limited remote operation is possible using the TTL input or the analog inputs and outputs.

The following control or read out functions are available:

LD REM

This digital input allows to switch on/off the laser independent of the key “LASER ON”. A rising edge at this input switches the laser on (if being in off state), a falling edge switches the laser off (if being in on state). The threshold voltages are TTL compatible and feature hysteresis.

When using the “LD REM” input, the key “LASER ON” remains fully functional.

Interlock

If a relay contact or an open collector transistor is inserted into the interlock line (refer to section "[Interlock](#)"^[13]"), the output can be switched off remotely at any time.

Note

The interlock is usable only for switching off. After the interlock path was interrupted, the LDC200C Series Controller can be switched on again only manually, provided the Interlock is closed.

Setting the laser diode current

The analog modulation input “MOD IN” input (R2) is DC coupled; the input voltage ranges from -10V to + 10V. The input resistance of the input “MOD IN” is >10 kΩ.

A voltage applied to this input is converted to a current value, which is then superposed to the LD set value, adjusted with the rotary knob F9. The conversion coefficient depends on the max. nominal output current of the controller and can be calculated to

$$k_{MOD} = I_{max} / 10V [mA/V]$$

where I_{max} is the max. output current for the given controller.

Example:

For a LDC202C with a max. output current of 200mA the conversion coefficient k_{MOD} is equal to 20mA/V.

If the adjusting knob (F9) is set to it's left stop position, corresponding to a zero injection current, the laser diode set current value can be controlled externally by an analog DC voltage of (0...+10) V applied to the “MOD IN” input (R2).

If knob F9 is at its right stop position (corresponding to the max. injection current), a DC voltage of (-10...0) V can be used to decrease the injection current.

Note

The laser current output must be switched on, otherwise a current control via MOD IN is impossible.

Monitoring the laser current

The output "CTL OUT" (R3)¹⁰ delivers a DC voltage, proportional to the actual laser current. The output voltage ranges from:

- 0 ... +10 V with cathode grounded
- 0 ... -10 V with anode grounded.

Load resistance should be >10 kΩ. The conversion coefficient for this output is the multiplicative inverse of k_{MOD} :

$$k_{CTL\ OUT} = 10V/I_{max} \text{ [V/mA]}$$

Note

All operating elements of the LDC2xxC are active at any time. For remote operation, make sure that the manual settings are not changed during operation.

4 Maintenance and Service

Protect the LDC200C Series from adverse weather conditions. The LDC200C Series is not water resistant.

Attention

To avoid damage to the instrument, do not expose it to spray, liquids or solvents!

The unit does not need a regular maintenance by the user. If necessary the unit and the display can be cleaned with a cloth dampened with water. A mild 75% Isopropyl Alcohol solution can be used for more efficient cleaning.

LDC200C Series Controllers do not contain any modules and/or components that could be repaired by the user himself. If a malfunction occurs, please contact [Thorlabs](#)^[36] for return instructions.

Do not remove covers!

To guarantee the specifications given in section [Technical Data](#)^[24] over a long period it is recommended to have the unit factory calibrated every two years.

4.1 Line Voltage Setting

The laser diode controller LDC2xxC operates at fixed line voltages of

100 V +15% / -10% (90 V ... 115 V)

115 V +15% / -10% (104 V ... 132 V)

230 V +15% / -10% (207 V ... 264 V)

line frequency 50 ... 60 Hz.

The line voltage setting can be changed from the rear without opening the unit.

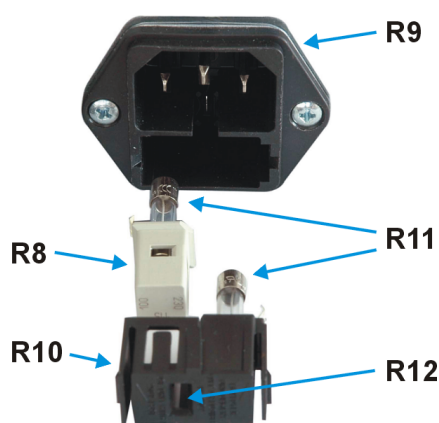

1. Turn off the controller and disconnect the mains cable.

2. The fuse holder (R10) is located below the 3-pole power connector of the mains jack (R9). Release the fuse holder by pressing its plastic retainers with the aid of a small screwdriver. The retainers are located on the right and left side of the holder and must be pressed towards the center.

3. Unplug the white line voltage switch/indicator (R8, containing the left fuse) from the fuse holder (R10), rotate it until the appropriate voltage marking (100V, 115V, or 230V) is on target for the cutout (R12) of the fuse holder, and plug it back into the fuse holder. Press in the fuse holder until locked on both sides. The appropriate line

voltage marking must be visible in the cutout (R12) of the fuse holder.

Attention

If you have changed to or from 230 V, also change the mains fuses to the correct value given in section [Replacing Mains Fuses](#)^[21].

4.2 Replacing Mains Fuses

The two power input fuses are externally accessible. If they blew due to line distortions, incorrect line voltage or other causes, they can be replaced from the rear without opening the unit.

Attention

To avoid risk of fire only the appropriate fuses for the corresponding line voltage must be used

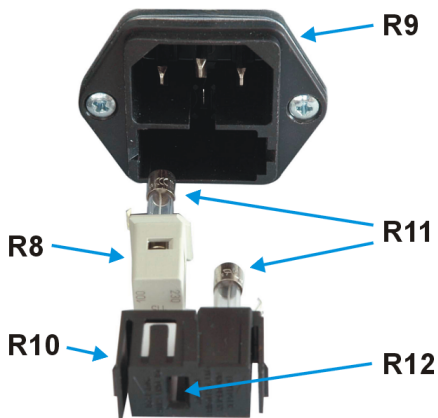

1. Turn off the LDC2xxC and disconnect the mains cable.
2. The fuse holder (R10) is located below the 3-pole power connector of the mains jack (R9). Release the fuse holder by pressing its plastic retainers using a small screwdriver. The retainers are located on the right and left side of the holder and must be pressed towards the center.
3. Replace the defective fuses (R11) and press in the fuse holder until locked on both sides. Take care to maintain the correct rotation of the white line voltage indicator / switch (R8) which contains the left fuse and is plugged into the fuse holder. The appropriate line voltage marking must be visible in the cutout (R12) of the fuse holder.

Fuse types

LDC200VC, LDC201CU, LDC202C, LDC205C, LDC210C, and LDC220C:

100 V	500 mA, time-lag, 250V	T0.5A250V
115 V	500 mA, time-lag, 250V	T0.5A250V
230 V	250 mA, time-lag, 250V	T0.25A250V

LDC240C:

100 V	800 mA, time-lag, 250V	T0.8A250V
115 V	800 mA, time-lag, 250V	T0.8A250V
230 V	400 mA, time-lag, 250V	T0.4A250V

All fuses must meet IEC specification 60127-2/III, time characteristic: time-lag (T), 250V AC, size 5 x 20 mm.

4.3 Troubleshooting

In case that your LDC200C Series Controller shows malfunction please check the following items:

□ Unit does not work at all (no display at the front):

- LDC2xxC connected properly to the mains?
 - Check the power cord and the [line voltage setting](#) ^[20]
- LDC2xxC turned on?
 - Turn on your LDC200C Series Controller (button "LINE" F10).
- Check the [fuses](#) ^[21] at the rear panel.
 - If blown, replace the fuses with the correct type.

□ The desired laser output power cannot be achieved

- Is the interlock closed?
 - Check the connection of [interlock](#) ^[13] pins of the connector jack.
- Is the laser output turned on ("LASER ON" button)?
 - Change the setting from "OFF" to "ON". The LED "ON" on the front panel of the mainframe must light up.
- Is the current limit I_{LIM} set to 0?
 - Adjust the [hardware limit I](#) ^[14] I_{LIM} ^[14] (potentiometer on the front panel) to an appropriate value.
- Is the laser diode installed properly?
 - Check the connection cable.
- Is the polarity of the laser diode set correctly?
 - If not change the polarity of the diode or select on the LDC2xxC the [opposite polarity](#) ^[12].
- Is the photodiode connected properly?
 - Check the connection cable.
- Is the photodiode poled correctly?
 - If in constant power mode the displayed photodiode current is negative, the polarity of the photodiode must be reverted.
- Are you using a [bias voltage](#) ^[12] with the photodiode in photo current mode?
 - Change the polarity of the diode for photo element mode or change the polarity of the bias voltage source.
- Is the desired output power set correctly?
 - Check the optical [power display calibration](#) ^[16]
 - Adjust the desired output power P_{LD} using the tuning knob.

- The unit switches on, but display shows error message (e.g., “Err06”)
 - This indicates a malfunction of the LDC200C Series Controller.
 - In such case, the controller needs to be returned to Thorlabs for maintenance. Please contact [Thorlabs](#)³⁶ with the information of the error code number and the serial number of your LDC200C Series Controller in order to receive the RMA (Return Material Authorization) instructions accordingly.

If you don't find the error source by means of the trouble shooting list please contact [Thorlabs](#)³⁶ for advise and/or return instructions

5 Appendix

5.1 Technical Data

Common Technical Data

General Data	
Safety Features	Interlock Laser Current Limit Soft Start Short Circuit when Laser off Open Circuit Detection Overtemperature Protection
Display	LED, 5 Digits
Connector for Laser, Photodiode, Interlock & Laser On Signal	9-pin D-Sub Jack
Connectors for Control Input / Output	BNC
Chassis Ground Connector	4mm Banana Jack
Line Voltage	100 V 115 V +15% / -10% 230 V
Mains Supply Overvoltage	Category II (Cat II)
Line Frequency	50 to 60 Hz
Operating Temperature Range ¹⁾	0°C to +40 °C
Storage Temperature Range	-40°C to +70 °C
Relative Humidity	Max. 80% up to 31 °C, decreasing to 50% at 40 °C
Pollution Degree (Indoor Use only)	2
Operation Altitude	<2000 m
Warm-up Time for Rated Accuracy	10 min
Dimensions (W x H x D) w/o Operating Elements with Operating Elements	146 x 66 x 290 mm ³ 146 x 77 x 320 mm ³

¹⁾ non-condensing

All technical data are valid at 23 ± 5°C and 45 ± 15% rel. humidity (non condensing)

5.1.1 LDC200CV

Current Control (Constant Current Mode)	
Control Range	0 to ± 20 mA
Compliance Voltage	>6 V
Resolution	1.0 μ A
Accuracy	± 20 μ A
Noise Without Ripple (10Hz to 10MHz, rms, typ.)	<1.0 μ A
Ripple (50/60Hz, rms, typ.)	<0.5 μ A
Transients (typ.)	<10 μ A
Drift, 24hours (typ., 0-10Hz, at constant ambient temperature)	<1 μ A
Temperature Coefficient	<50 ppm/ $^{\circ}$ C
Current Limit	
Setting Range	0 to >20 mA
Resolution	1 μ A
Accuracy	± 50 μ A
Power Control (Constant Power Mode)	
Photo Current Control Range	5 μ A to 2 mA
Photo Current Resolution	0.1 μ A
Photo Current Accuracy	± 2 μ A
Analog Modulation Input	
Input Resistance	10 k Ω
Small Signal 3dB Bandwidth, CC Mode	DC to 100 kHz
Modulation Coefficient, CC Mode	2 mA/V $\pm 5\%$
Modulation Coefficient, CP Mode	0.2 mA/V $\pm 5\%$
Laser Current Monitor Output	
Load Resistance	>10 k Ω
Transmission Coefficient	500 V/A $\pm 5\%$
General data	
Maximum Power Consumption	20 VA
Weight	<3.1 kg

All technical data are valid at $23 \pm 5^{\circ}$ C and $45 \pm 15\%$ humidity

5.1.2 LDC201CU

Current Control (Constant Current Mode)	
Control Range	0 to ± 100 mA
Compliance Voltage	>5 V
Resolution	10 μ A
Accuracy	± 50 μ A
Noise Without Ripple (10Hz to 10MHz, rms, typ.)	<0.2 μ A
Ripple (50/60Hz, rms, typ.)	<0.5 μ A
Transients (typ.)	<10 μ A
Drift, 24hours (typ., 0-10Hz, at constant ambient temperature)	<2 μ A
Temperature Coefficient	<50 ppm/ $^{\circ}$ C
Current Limit	
Setting Range	0 to >100 mA
Resolution	10 μ A
Accuracy	± 200 μ A
Power Control (Constant Power Mode)	
Photo Current Control Range	25 μ A to 10 mA
Photo Current Resolution	1 μ A
Photo Current Accuracy	± 10 μ A
Analog Modulation Input	
Input Resistance	10 k Ω
Small Signal 3dB Bandwidth, CC Mode	DC to 0.2 kHz
Modulation Coefficient, CC Mode	10 mA/V $\pm 5\%$
Modulation Coefficient, CP Mode	1 mA/V $\pm 5\%$
Laser Current Monitor Output	
Load Resistance	>10 k Ω
Transmission Coefficient	100 V/A $\pm 5\%$
General data	
Maximum Power Consumption	20 VA
Weight	<3.1 kg

All technical data are valid at $23 \pm 5^{\circ}$ C and $45 \pm 15\%$ humidity

5.1.3 LDC202C

Current Control (Constant Current Mode)	
Control Range	0 to ± 200 mA
Compliance Voltage	>10 V
Resolution	10 μ A
Accuracy	± 100 μ A
Noise Without Ripple (10Hz to 10MHz, rms, typ.)	<1.5 μ A
Ripple (50/60Hz, rms, typ.)	<1.5 μ A
Transients (typ.)	<0.2 mA
Drift, 24hours (typ., 0-10Hz, at constant ambient temperature)	<3 μ A
Temperature Coefficient	<50 ppm/ $^{\circ}$ C
Current Limit	
Setting Range	0 to >200 mA
Resolution	10 μ A
Accuracy	± 500 μ A
Power Control (Constant Power Mode)	
Photo Current Control Range	25 μ A to 10 mA
Photo Current Resolution	1 μ A
Photo Current Accuracy	± 10 μ A
Analog Modulation Input	
Input Resistance	10 k Ω
Small Signal 3dB Bandwidth, CC Mode	DC to 250 kHz
Modulation Coefficient, CC Mode	20 mA/V $\pm 5\%$
Modulation Coefficient, CP Mode	1 mA/V $\pm 5\%$
Laser Current Monitor Output	
Load Resistance	>10 k Ω
Transmission Coefficient	50 V/A $\pm 5\%$
General data	
Maximum Power Consumption	25 VA
Weight	<3.1 kg

All technical data are valid at $23 \pm 5^{\circ}$ C and $45 \pm 15\%$ humidity

5.1.4 LDC205C

Current Control (Constant Current Mode)	
Control Range	0 to ± 500 mA
Compliance Voltage	>10 V
Resolution	10 μ A
Accuracy	± 0.5 mA
Noise Without Ripple (10Hz to 10MHz, rms, typ.)	< 3 μ A
Ripple (50/60Hz, rms, typ.)	< 2 μ A
Transients (typ.)	< 0.5 mA
Drift, 24hours (typ., 0-10Hz, at constant ambient temperature)	<10 μ A
Temperature Coefficient	<50 ppm/ $^{\circ}$ C
Current Limit	
Setting Range	0 to >500 mA
Resolution	10 μ A
Accuracy	± 1.5 mA
Power Control (Constant Power Mode)	
Photo Current Control Range	25 μ A to 10 mA
Photo Current Resolution	1 μ A
Photo Current Accuracy	± 10 μ A
Analog Modulation Input	
Input Resistance	10 k Ω
Small Signal 3dB Bandwidth, CC Mode	DC to 150 kHz
Modulation Coefficient, CC Mode	50 mA/V $\pm 5\%$
Modulation Coefficient, CP Mode	1 mA/V $\pm 5\%$
Laser Current Monitor Output	
Load Resistance	>10 k Ω
Transmission Coefficient	20 V/A $\pm 5\%$
General data	
Maximum Power Consumption	30 VA
Weight	<3.1 kg

All technical data are valid at $23 \pm 5^{\circ}$ C and $45 \pm 15\%$ humidity

5.1.5 LDC210C

Current Control (Constant Current Mode)	
Control Range	0 to ± 1 A
Compliance Voltage	>10 V
Resolution	100 μ A
Accuracy	± 1.0 mA
Noise Without Ripple (10Hz to 10MHz, rms, typ.)	<5 μ A
Ripple (50/60Hz, rms, typ.)	<3 μ A
Transients (typ.)	<1 mA
Drift, 24hours (typ., 0-10Hz, at constant ambient temperature)	<20 μ A
Temperature Coefficient	<50 ppm/ $^{\circ}$ C
Current Limit	
Setting Range	0 to >1 A
Resolution	100 μ A
Accuracy	± 2.5 mA
Power Control (Constant Power Mode)	
Photo Current Control Range	50 μ A to 20 mA
Photo Current Resolution	1 μ A
Photo Current Accuracy	± 20 μ A
Analog Modulation Input	
Input Resistance	10 k Ω
Small Signal 3dB Bandwidth, CC Mode	DC to 100 kHz
Modulation Coefficient, CC Mode	100 mA/V $\pm 5\%$
Modulation Coefficient, CP Mode	2 mA/V $\pm 5\%$
Laser Current Monitor Output	
Load Resistance	>10 k Ω
Transmission Coefficient	10 V/A $\pm 5\%$
General data	
Maximum Power Consumption	40 VA
Weight	<3.1 kg

All technical data are valid at $23 \pm 5^{\circ}$ C and $45 \pm 15\%$ humidity

5.1.6 LDC220C

Current Control (Constant Current Mode)	
Control Range	0 to ± 2 A
Compliance Voltage	>4 V
Resolution	100 μ A
Accuracy	± 2.0 mA
Noise Without Ripple (10Hz to 10MHz, rms, typ.)	<15 μ A
Ripple (50/60Hz, rms, typ.)	<5 μ A
Transients (typ.)	<2 mA
Drift, 24hours (typ., 0-10Hz, at constant ambient temperature)	<100 μ A
Temperature Coefficient	<50 ppm/ $^{\circ}$ C
Current Limit	
Setting Range	0 to >2 A
Resolution	100 μ A
Accuracy	± 5 mA
Power Control (Constant Power Mode)	
Photo Current Control Range	50 μ A to 20 mA
Photo Current Resolution	1 μ A
Photo Current Accuracy	± 20 μ A
Analog Modulation Input	
Input Resistance	10 k Ω
Small Signal 3dB Bandwidth, CC Mode	DC to 50 kHz
Modulation Coefficient, CC Mode	200 mA/V $\pm 5\%$
Modulation Coefficient, CP Mode	2 mA/V $\pm 5\%$
Laser Current Monitor Output	
Load Resistance	>10 k Ω
Transmission Coefficient	5 V/A $\pm 5\%$
General data	
Maximum Power Consumption	60 VA
Weight	<3.3 kg

All technical data are valid at $23 \pm 5^{\circ}$ C and $45 \pm 15\%$ humidity

5.1.7 LDC240C

Current Control (Constant Current Mode)	
Control Range	0 to ± 4 A
Compliance Voltage	>5 V
Resolution	100 μ A
Accuracy	± 4.0 mA
Noise Without Ripple (10Hz to 10MHz, rms, typ.)	<50 μ A
Ripple (50/60Hz, rms, typ.)	<8 μ A
Transients (typ.)	<4 mA
Drift, 24hours (typ., 0-10Hz, at constant ambient temperature)	<200 μ A
Temperature Coefficient	<50 ppm/ $^{\circ}$ C
Current Limit	
Setting Range	0 to >4 A
Resolution	100 μ A
Accuracy	± 10 mA
Power Control (Constant Power Mode)	
Photo Current Control Range	50 μ A to 20 mA
Photo Current Resolution	1 μ A
Photo Current Accuracy	± 20 μ A
Analog Modulation Input	
Input Resistance	10 k Ω
Small Signal 3dB Bandwidth, CC Mode	DC to 30 kHz
Modulation Coefficient, CC Mode	400 mA/V $\pm 5\%$
Modulation Coefficient, CP Mode	2 mA/V $\pm 5\%$
Laser Current Monitor Output	
Load Resistance	>10 k Ω
Transmission Coefficient	2.5 V/A $\pm 5\%$
General data	
Maximum Power Consumption	100 VA
Weight	<3.3 kg

All technical data are valid at $23 \pm 5^{\circ}$ C and $45 \pm 15\%$ humidity

5.2 Certifications and Compliances

Category	Standards or description		
EC Declaration of Conformity - EMC	Meets intent of Directive 2004/108/EC ¹ for Electromagnetic Compatibility. Compliance was demonstrated to the following specifications as listed in the Official Journal of the European Communities:		
	EN 61326: Apr.1997 +A1:1998 +A2:2001 +A3:2003	Electrical equipment for measurement, control and laboratory use – EMC requirements: Immunity: complies with immunity test requirements for equipment intended for use in industrial locations ^{2,3} . Emission: complies with EN 55011 Class B Limits ^{2,3,4} IEC 61000-3-2 and IEC 61000-3-3.	
	IEC 61000-4-2	Electrostatic Discharge Immunity (Performance Criterion B)	
	IEC 61000-4-3	Radiated RF Electromagnetic Field Immunity (Performance Criterion A) ⁵	
	IEC 61000-4-4	Electrical Fast Transient / Burst Immunity (Performance Criterion A)	
	IEC 61000-4-5	Power Line Surge Immunity (Performance Criterion A)	
	IEC 61000-4-6	Conducted RF Immunity (Performance Criterion A)	
	IEC 61000-4-11	Voltage Dips, Short Interruptions and Voltage Variations Immunity (Performance Criterion A)	
	IEC 61000-3-2	AC Power Line Harmonic Emissions	
	IEC 61000-3-3	Voltage Fluctuations and Flicker	
FCC EMC Compliance	Emissions comply with the Class B Limits of FCC Code of Federal Regulations 47, Part 15, Subpart B ^{2,3,4} .		
EC Declaration of Conformity - Low Voltage	Compliance was demonstrated to the following specification as listed in the Official Journal of the European Communities: Low Voltage Directive 2006/95/EC ⁶		
	EN 61010-1:2010	Safety Requirements for Electrical Equipment for Measurement, Control and Laboratory Use	
	U.S. Nationally Recognized Testing Laboratory Listing		UL 61010-1 2 nd ed. ISA-82:02.01
	Canadian Certification		CAN/CSA C22.2 No. 61010-1 4 th ed.
	Additional Compliance		IEC 61010-1:2001
Equipment Type	Test and Measuring		
Safety Class	Class I equipment (as defined in IEC60950-1:2001)		
¹ Replaces 89/336/EEC. ² Compliance demonstrated using high-quality shielded interface cables shorter than or equal to 3 meters. ³ Compliance demonstrated with CAB400 cable installed at the LD OUT port. ⁴ Emissions, which exceed the levels required by these standards, may occur when this equipment is connected to a test object. ⁵ MOD IN port capped at IEC 61000-4-3 test. ⁶ Replaces 73/23/EEC, amended by 93/68/EEC			

5.3 Warranty

Thorlabs warrants material and production of the LDC200C Series for a period of 24 months starting with the date of shipment. During this warranty period Thorlabs will see to defaults by repair or by exchange if these are entitled to warranty.

For warranty repairs or service the unit must be sent back to Thorlabs. The customer will carry the shipping costs to Thorlabs, in case of warranty repairs Thorlabs will carry the shipping costs back to the customer.

If no warranty repair is applicable the customer also has to carry the costs for back shipment.

In case of shipment from outside EU duties, taxes etc. which should arise have to be carried by the customer.

Thorlabs warrants the hard- and software determined by Thorlabs for this unit to operate fault-free provided that they are handled according to our requirements. However, Thorlabs does not warrant a fault free and uninterrupted operation of the unit, of the software or firmware for special applications nor this instruction manual to be error free. Thorlabs is not liable for consequential damages.

Restriction of warranty

The warranty mentioned before does not cover errors and defects being the result of improper treatment, software or interface not supplied by us, modification, misuse or operation outside the defined ambient stated by us or unauthorized maintenance.

Further claims will not be consented to and will not be acknowledged. Thorlabs does explicitly not warrant the usability or the economical use for certain cases of application.

Thorlabs reserves the right to change this instruction manual or the technical data of the described unit at any time.

5.4 Copyright and Exclusion of Reliability

Thorlabs has taken every possible care in preparing this Operation Manual. We however assume no liability for the content, completeness or quality of the information contained therein. The content of this manual is regularly updated and adapted to reflect the current status of the software. We furthermore do not guarantee that this product will function without errors, even if the stated specifications are adhered to.

Under no circumstances can we guarantee that a particular objective can be achieved with the purchase of this product.

Insofar as permitted under statutory regulations, we assume no liability for direct damage, indirect damage or damages suffered by third parties resulting from the purchase of this product. In no event shall any liability exceed the purchase price of the product.

Please note that the content of this User Manual is neither part of any previous or existing agreement, promise, representation or legal relationship, nor an alteration or amendment thereof. All obligations of *Thorlabs* result from the respective contract of sale, which also includes the complete and exclusively applicable warranty regulations. These contractual warranty regulations are neither extended nor limited by the information contained in this User Manual. Should you require further information on this product, or encounter specific problems that are not discussed in sufficient detail in the User Manual, please contact your local *Thorlabs* dealer or system installer.

All rights reserved. This manual may not be reproduced, transmitted or translated to another language, either as a whole or in parts, without the prior written permission of *Thorlabs*.

Copyright © Thorlabs 2014. All rights reserved.

5.5 Thorlabs 'End of Life' Policy (WEEE)

As required by the WEEE (Waste Electrical and Electronic Equipment Directive) of the European Community and the corresponding national laws, Thorlabs offers all end users in the EC the possibility to return “end of life” units without incurring disposal charges.

This offer is valid for Thorlabs electrical and electronic equipment

- sold after August 13th 2005
- marked correspondingly with the crossed out “wheelie bin” logo (see figure below)
- sold to a company or institute within the EC
- currently owned by a company or institute within the EC
- still complete, not disassembled and not contaminated

As the WEEE directive applies to self contained operational electrical and electronic products, this “end of life” take back service does not refer to other Thorlabs products, such as

- pure OEM products, that means assemblies to be built into a unit by the user (e. g. OEM laser driver cards)
- components
- mechanics and optics
- left over parts of units disassembled by the user (PCB's, housings etc.).

Waste treatment on your own responsibility

If you do not return an “end of life” unit to Thorlabs, you must hand it to a company specialized in waste recovery. Do not dispose of the unit in a litter bin or at a public waste disposal site.

WEEE Number (Germany) : DE97581288

Ecological background

It is well known that waste treatment pollutes the environment by releasing toxic products during decomposition. The aim of the European RoHS Directive is to reduce the content of toxic substances in electronic products in the future.

The intent of the WEEE Directive is to enforce the recycling of WEEE. A controlled recycling of end-of-life products will thereby avoid negative impacts on the environment.



*Crossed out
"Wheelie Bin" symbol*

5.6 Thorlabs Worldwide Contacts

USA, Canada, and South America

Thorlabs, Inc.
56 Sparta Avenue
Newton, NJ 07860
USA
Tel: 973-579-7227
Fax: 973-300-3600
www.thorlabs.com
www.thorlabs.us (West Coast)
Email: sales@thorlabs.com
Support: techsupport@thorlabs.com

UK and Ireland

Thorlabs Ltd.
1 Saint Thomas Place, Ely
Cambridgeshire CB7 4EX
United Kingdom
Tel: +44-1353-654440
Fax: +44-1353-654444
www.thorlabs.com
Email: sales.uk@thorlabs.com
Support: techsupport.uk@thorlabs.com

Europe

Thorlabs GmbH
Hans-Böckler-Str. 6
85221 Dachau
Germany
Tel: +49-8131-5956-0
Fax: +49-8131-5956-99
www.thorlabs.de
Email: europe@thorlabs.com

Scandinavia

Thorlabs Sweden AB
Mölnadalsvägen 3
412 63 Göteborg
Sweden
Tel: +46-31-733-30-00
Fax: +46-31-703-40-45
www.thorlabs.com
Email: scandinavia@thorlabs.com

France

Thorlabs SAS
109, rue des Côtes
78600 Maisons-Laffitte
France
Tel: +33-970 444 844
Fax: +33-811 38 17 48
www.thorlabs.com
Email: sales.fr@thorlabs.com

Brazil

Thorlabs Vendas de Fotônicos Ltda.
Rua Riachuelo, 171
São Carlos, SP 13560-110
Brazil
Tel: +55-16-3413 7062
Fax: +55-16-3413 7064
www.thorlabs.com
Email: brasil@thorlabs.com

Japan

Thorlabs Japan, Inc.
Higashi Ikebukuro
Q Building 2nd Floor 2-23-2
Toshima-ku, Tokyo 170-0013
Japan
Tel: +81-3-5979-8889
Fax: +81-3-5979-7285
www.thorlabs.jp
Email: sales@thorlabs.jp

China

Thorlabs China
Room A101, No. 100
Lane 2891, South Qilianshan Road
Putuo District
Shanghai 200331
China
Tel: +86-21-60561122
Fax: +86-21-32513480
www.thorlabs.hk
Email: chinasales@thorlabs.com